

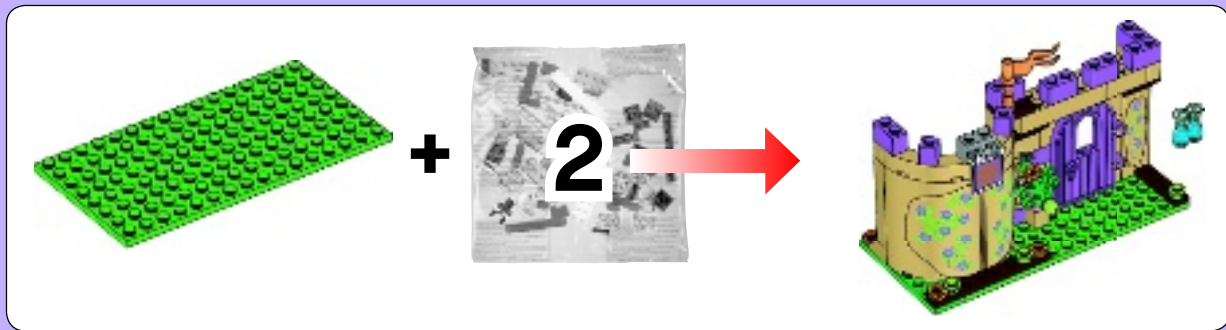

41051



 **WARNING: CHOKING HAZARD.**
Small parts. Not for children under 3 years.



⚠ Avertissement : RISQUE D'ÉTOUFFEMENT.

Contient des petites pièces. Ne convient pas aux enfants de moins de 3 ans.

⚠ Advertencia: PELIGRO DE ASFIXIA.

No recomendado para niños menores de 3 años. Contiene piezas pequeñas.



1x

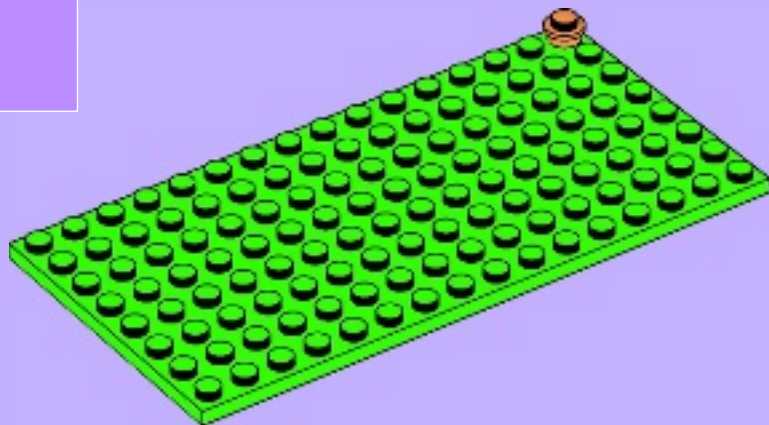

1

2

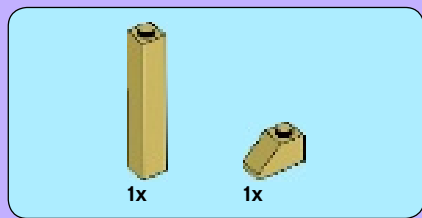

2

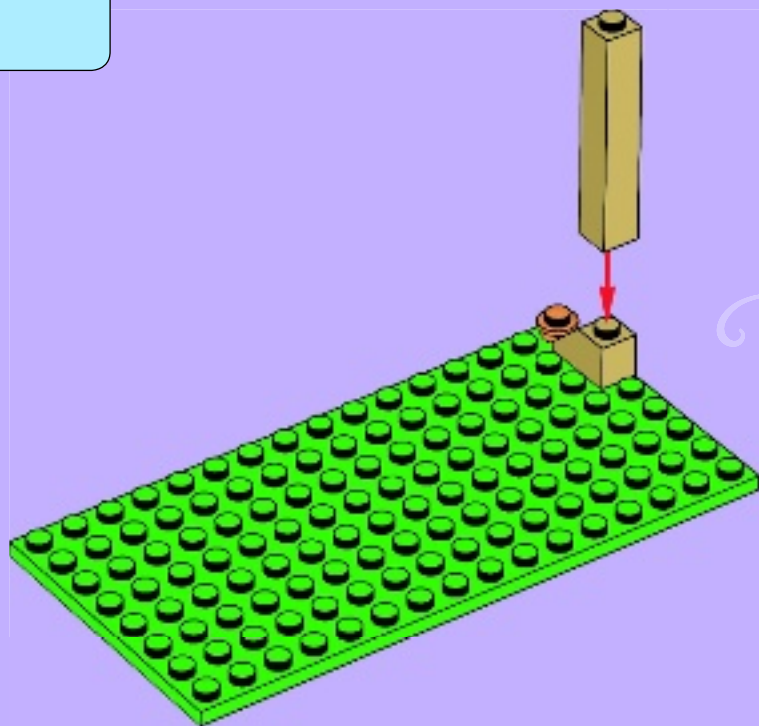

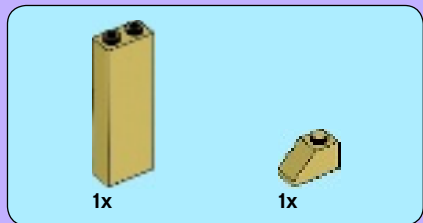

3

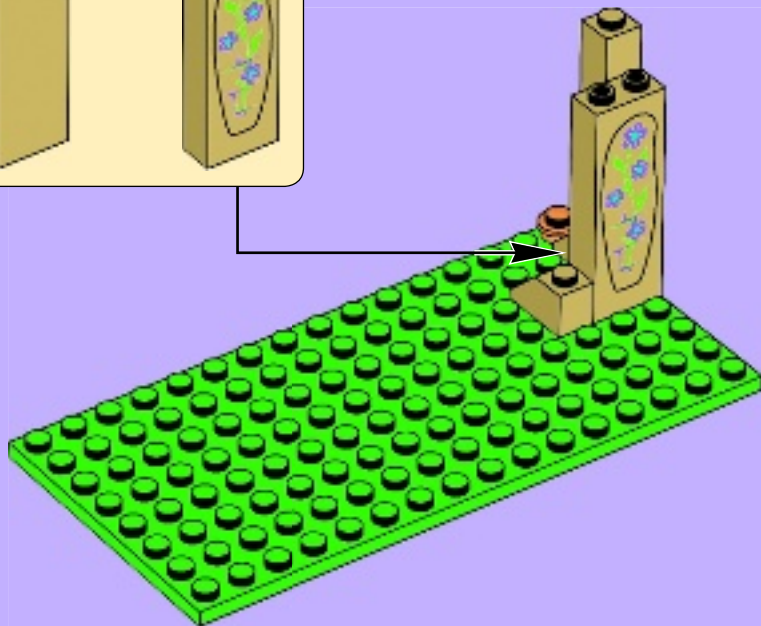
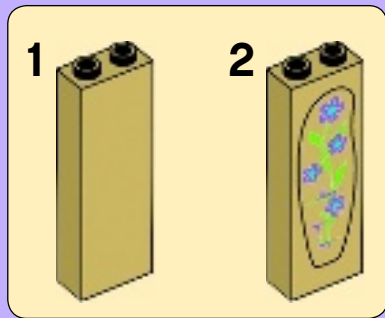

4



4

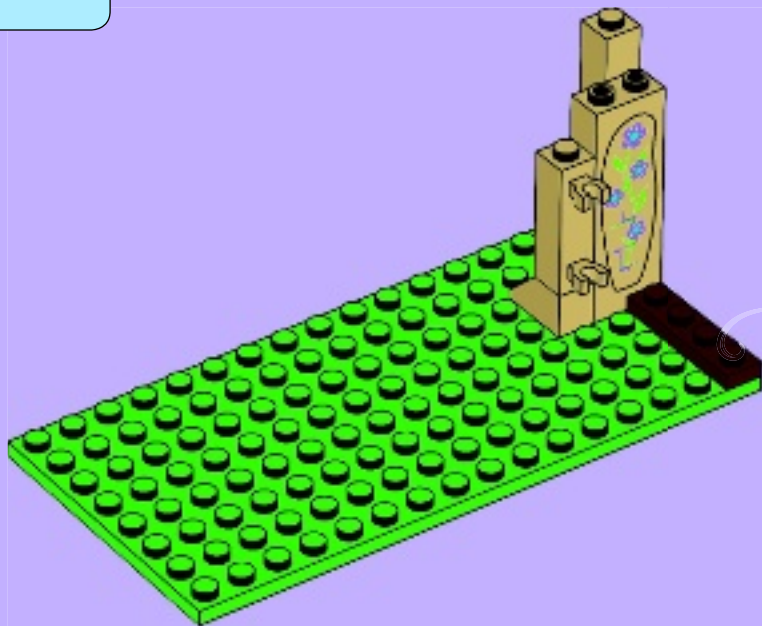



1x



1x

5

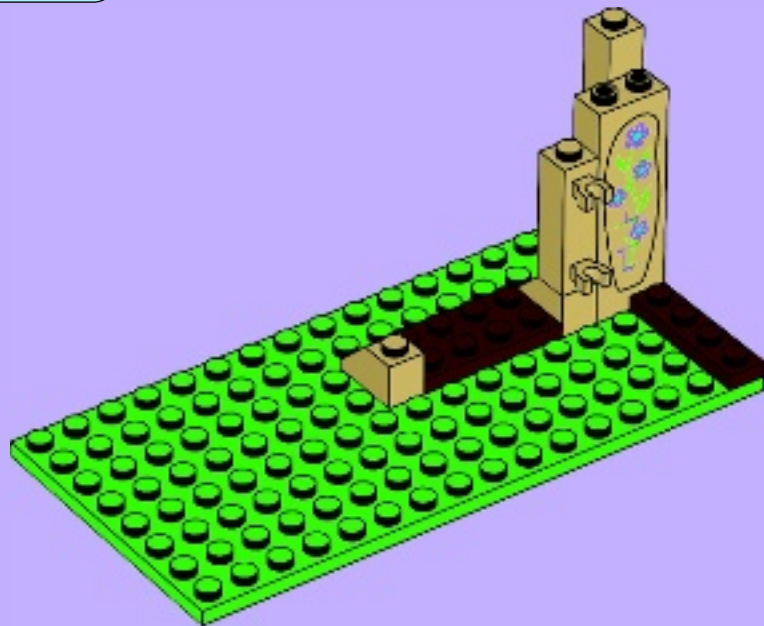

6



1x



1x

6

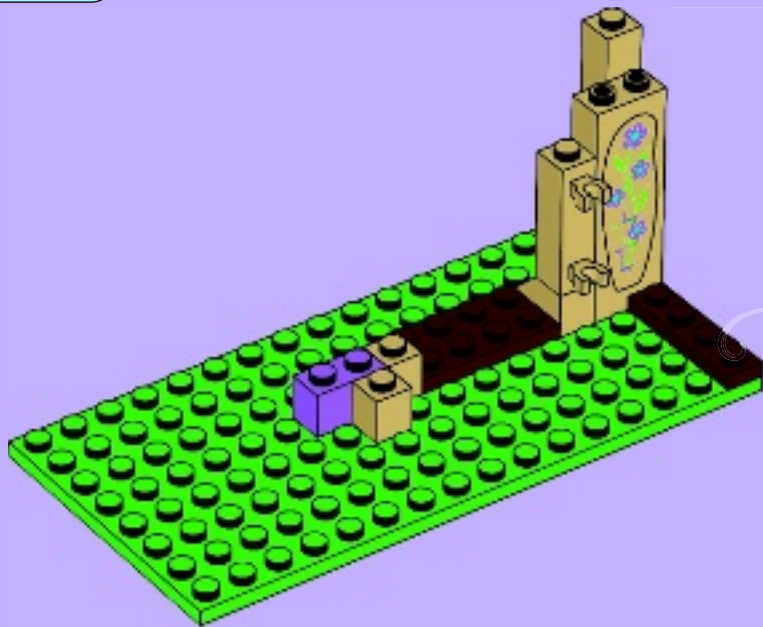



1x



1x

8

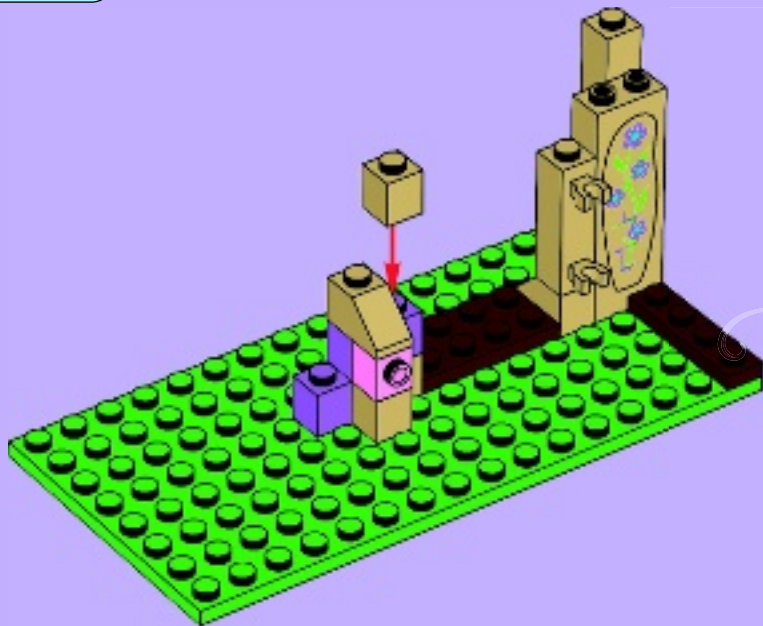



9

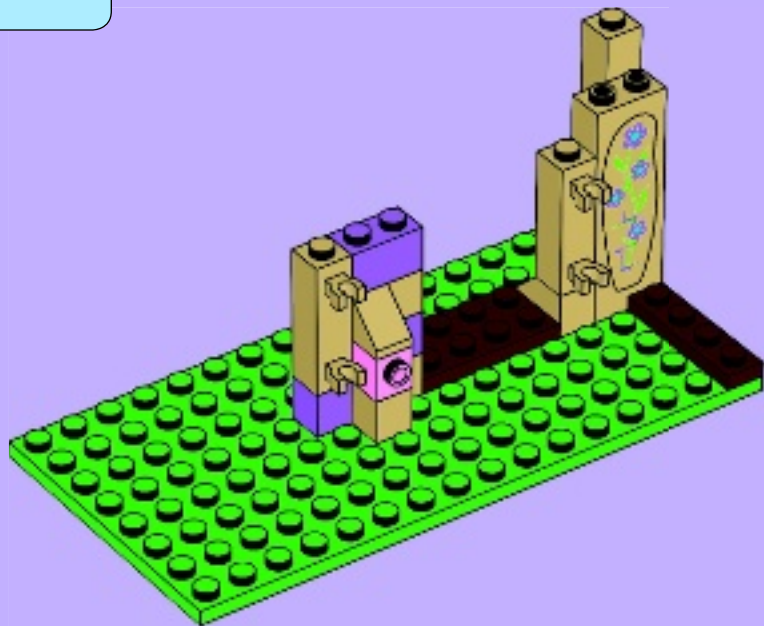

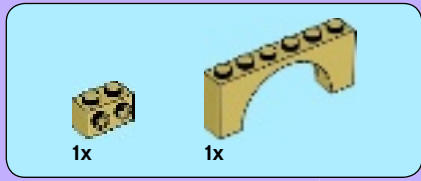

10

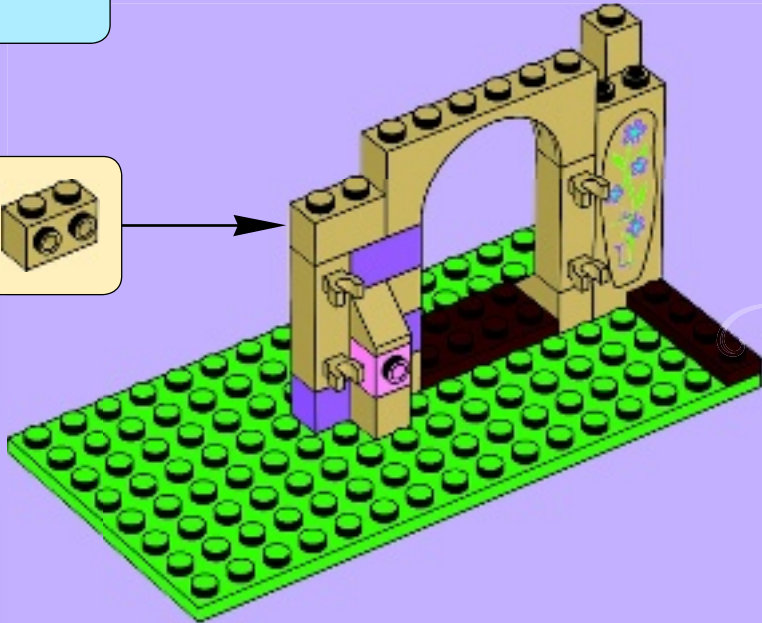
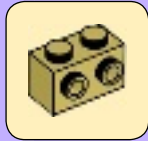



2x

11

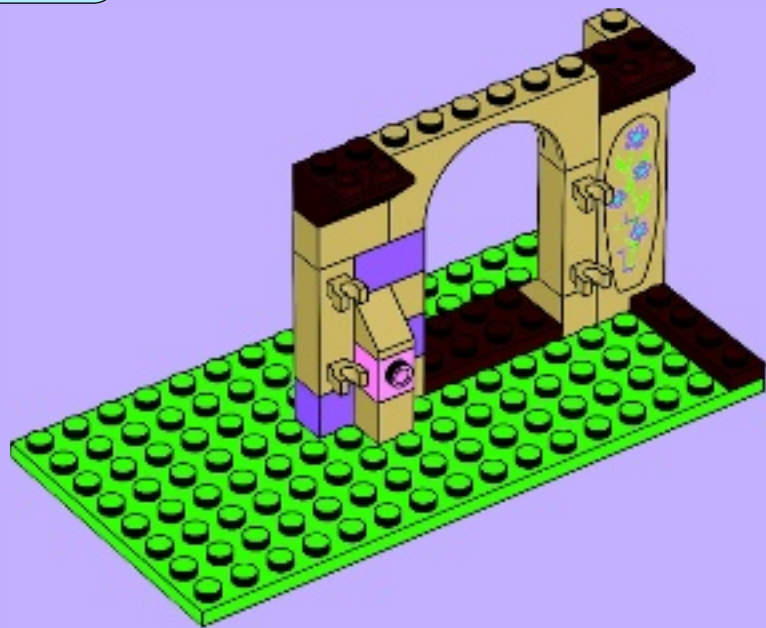

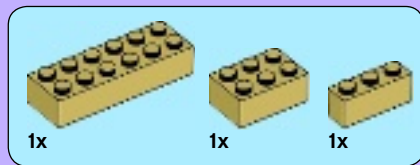

12

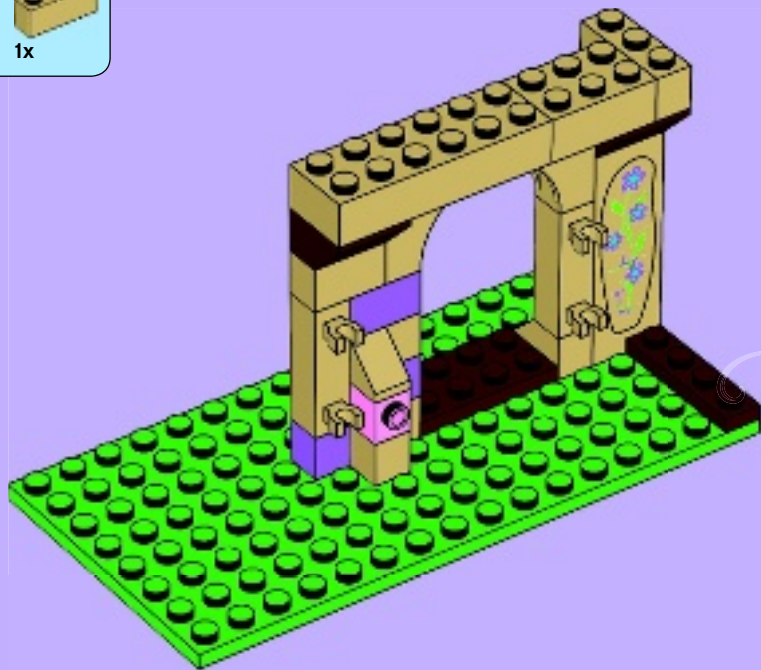

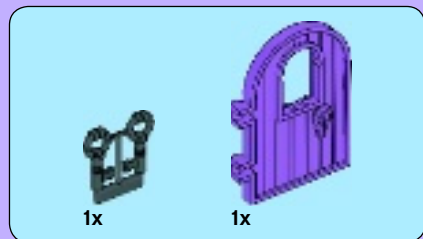

13

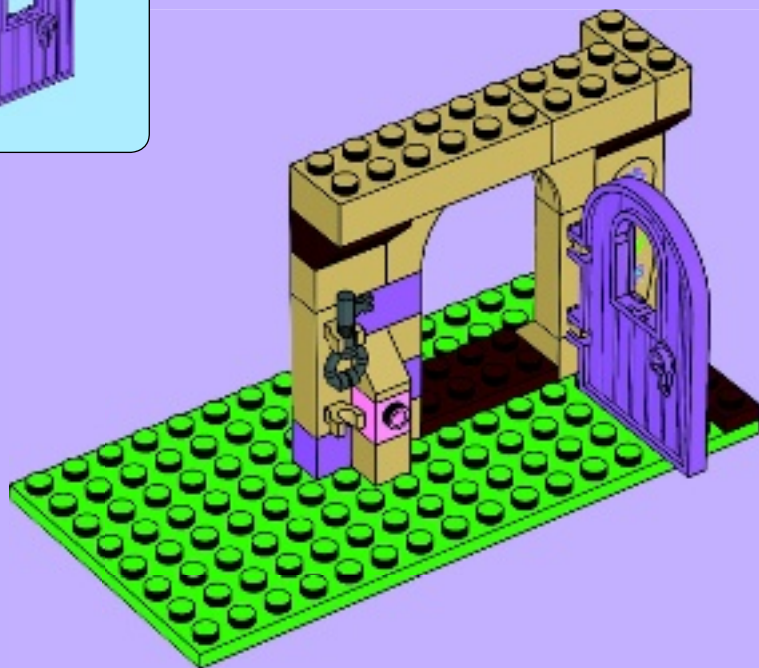

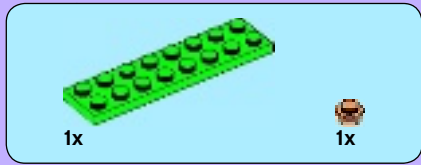

14

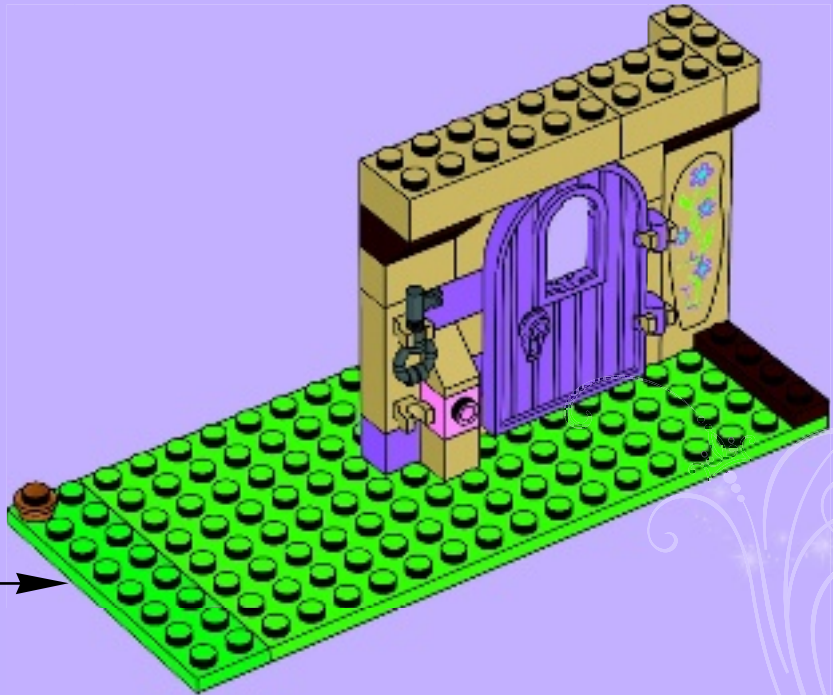
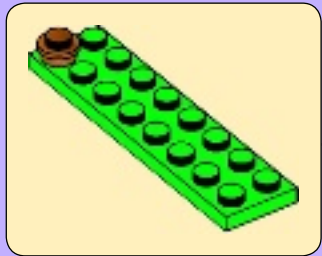



2x



1x

15

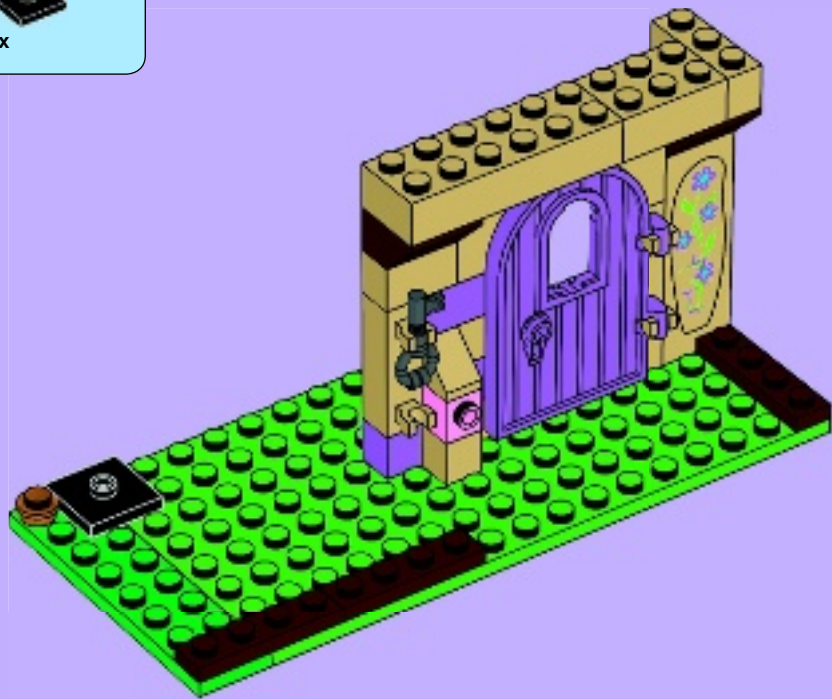

16

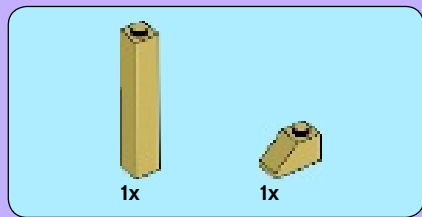

16

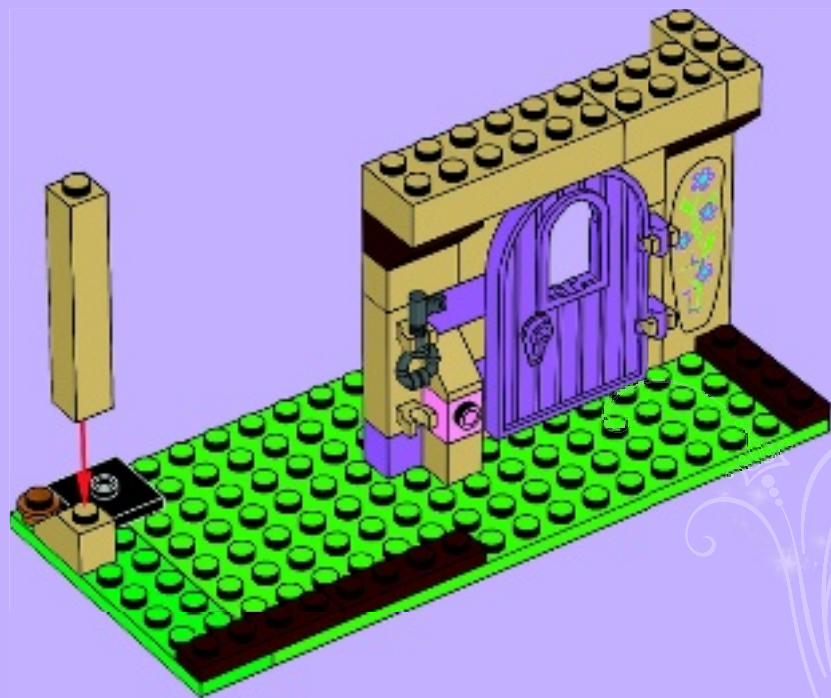

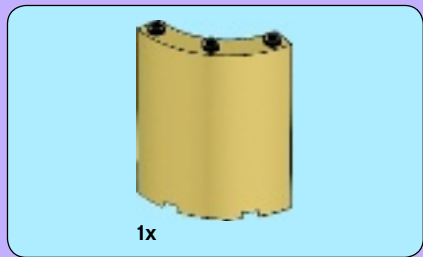

17

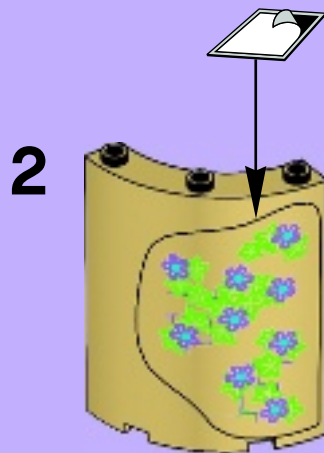
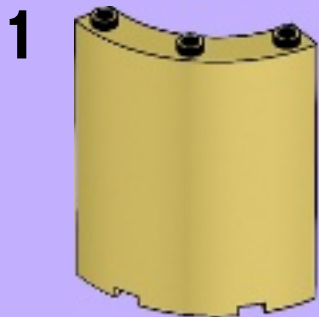

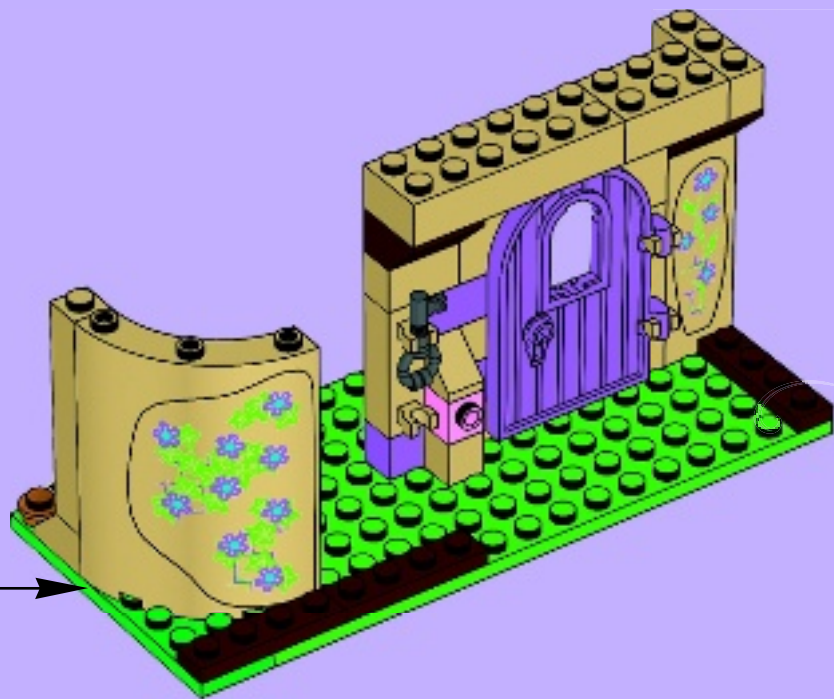

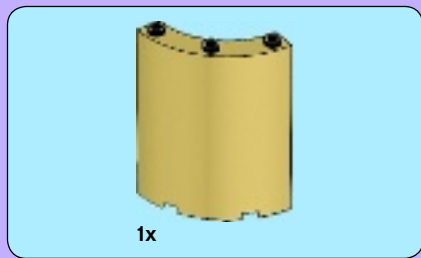

18

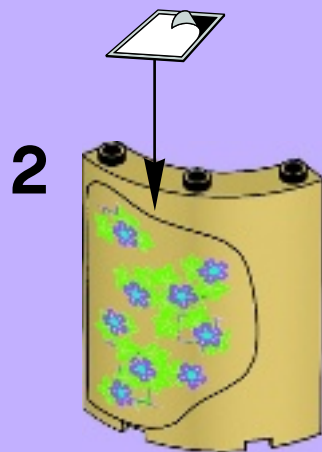
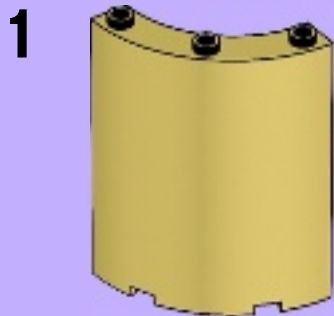

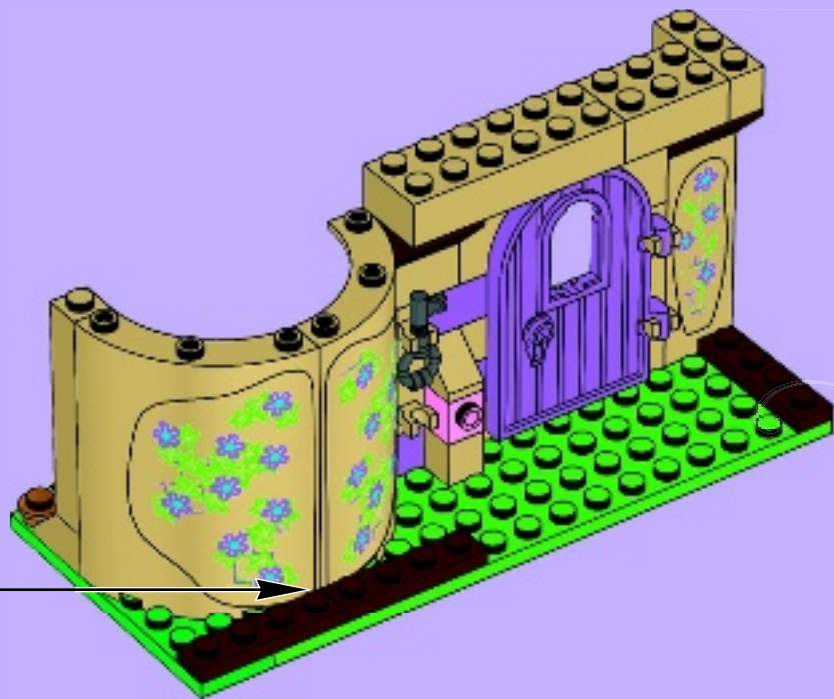



1x



2x

19

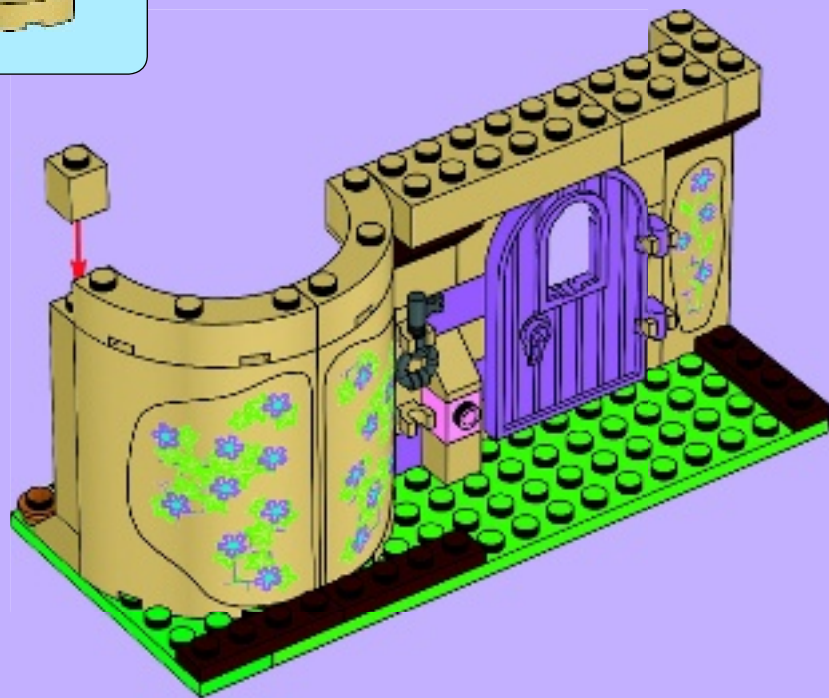



20

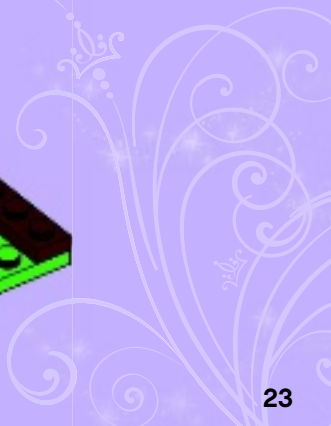
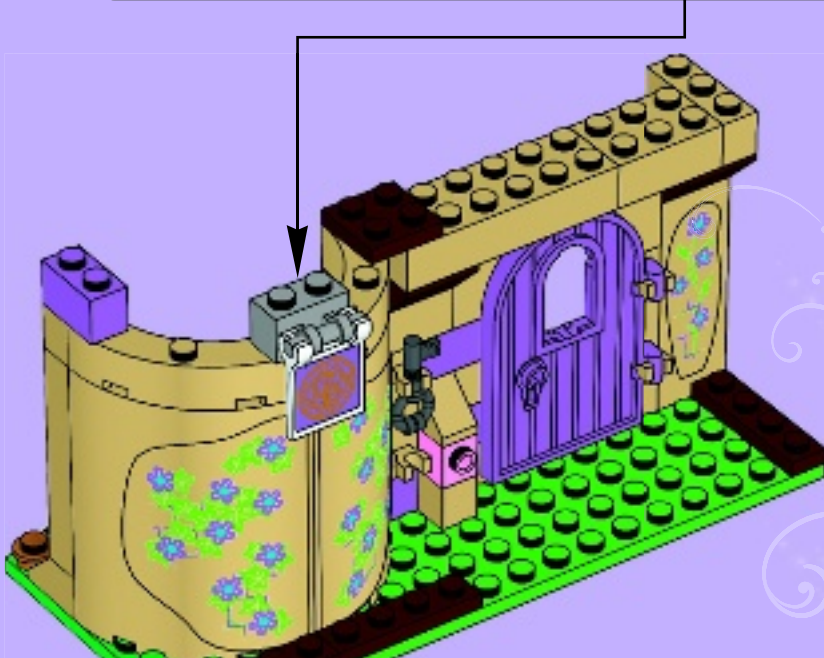
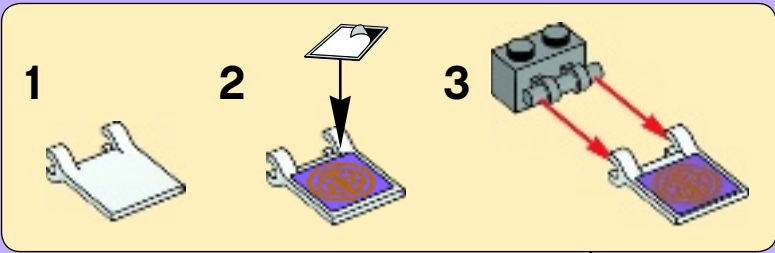



5x

21

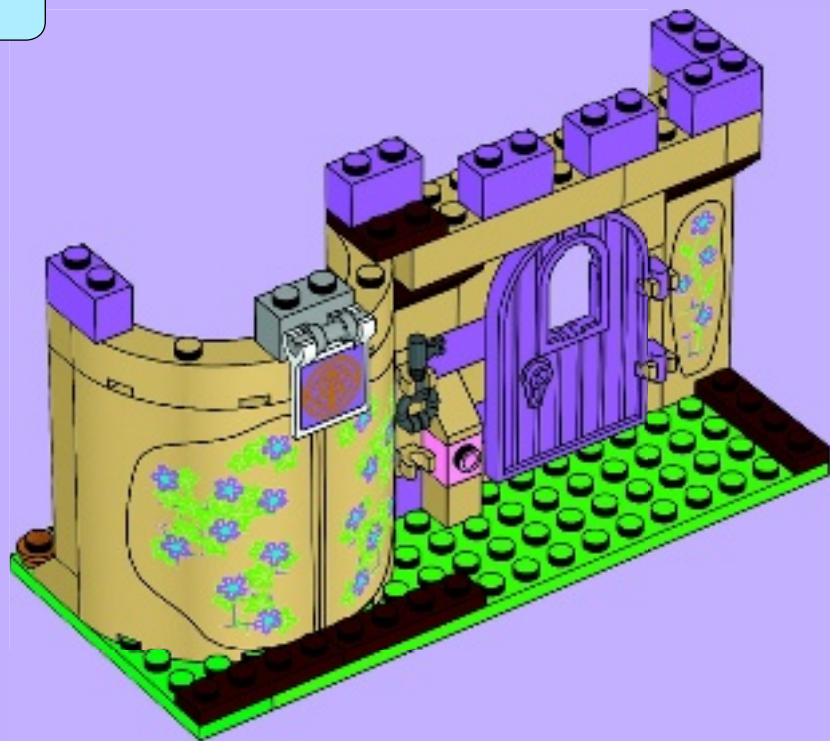

24



1x



1x



2x

22

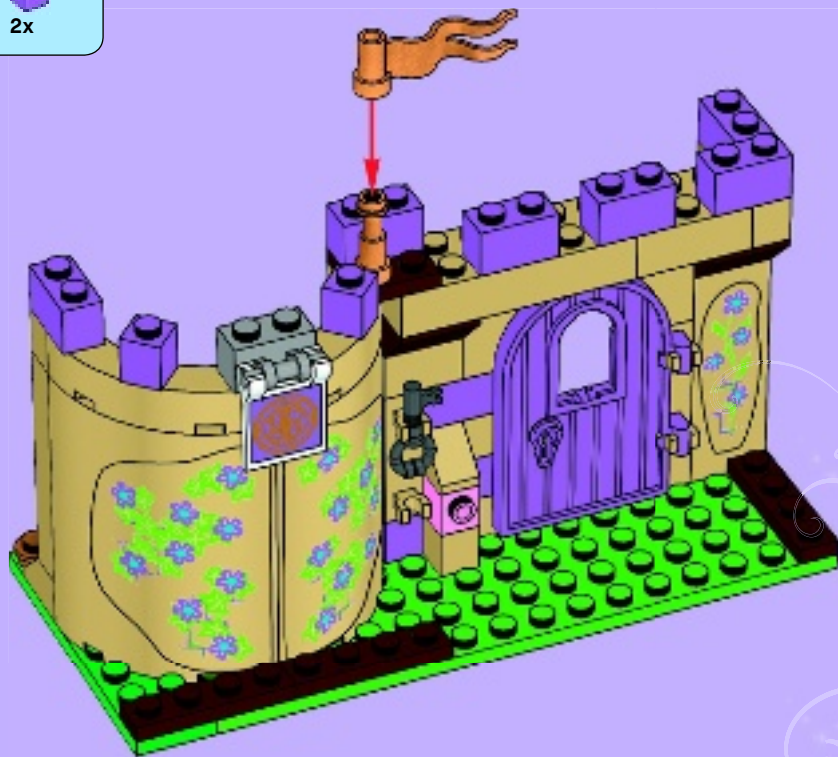



1x



1x

23

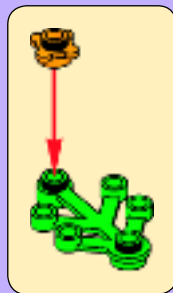



25

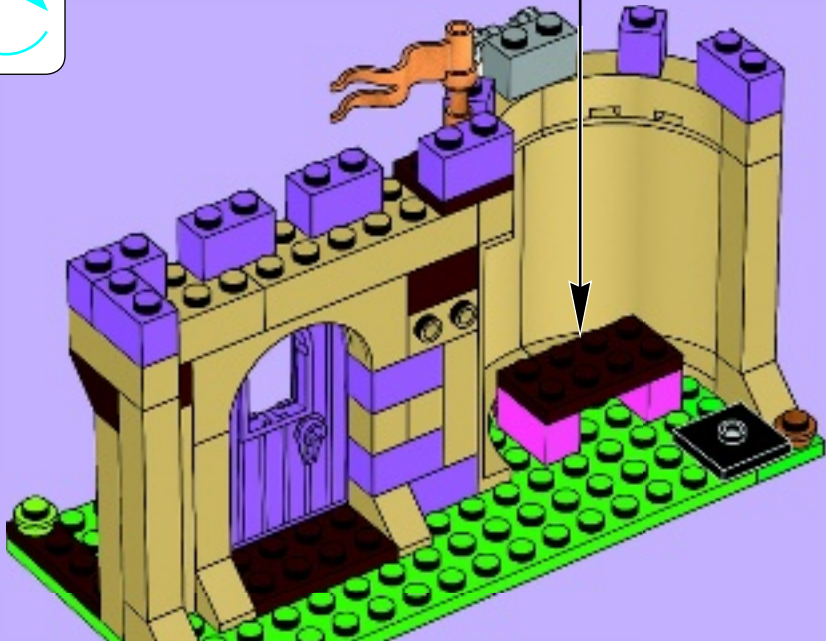
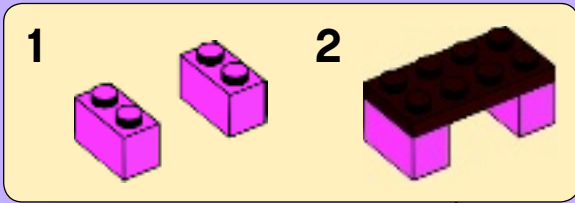



1x



1x



1x

26

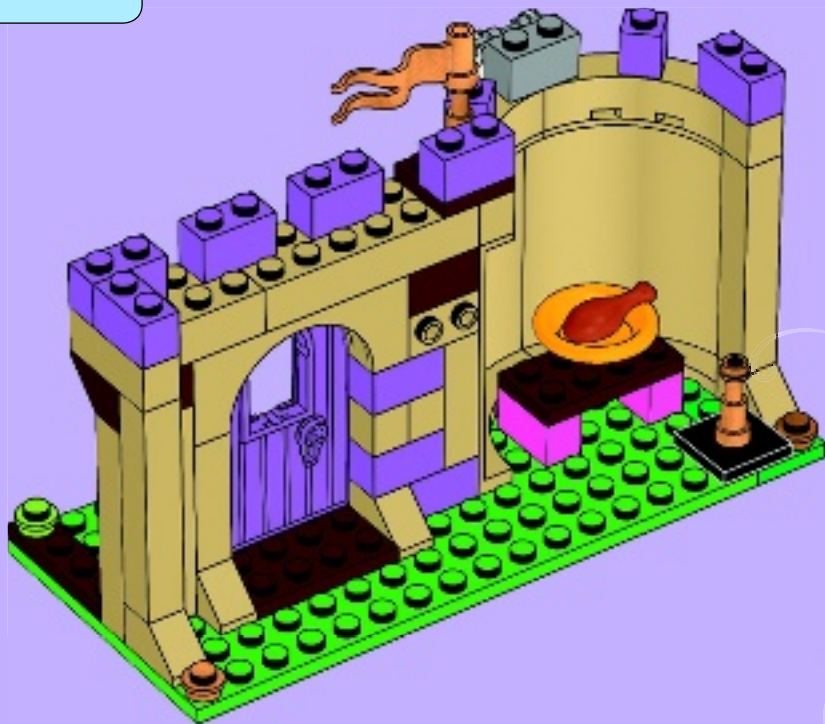

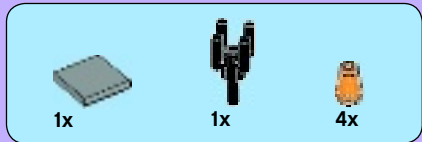

27

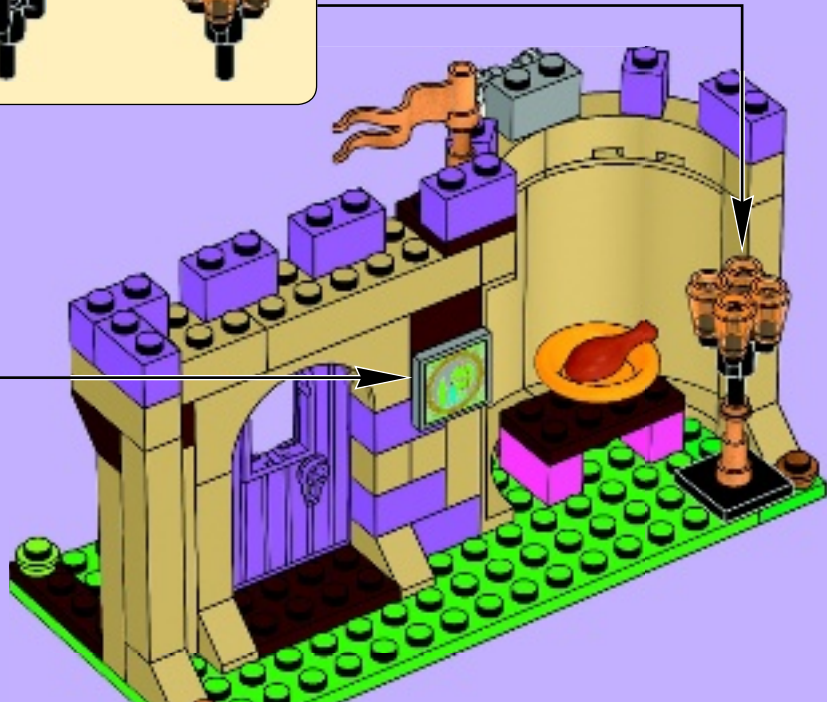
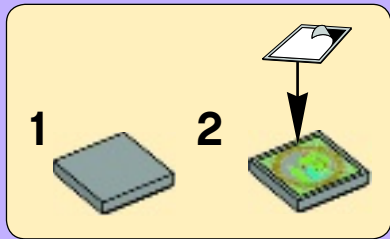
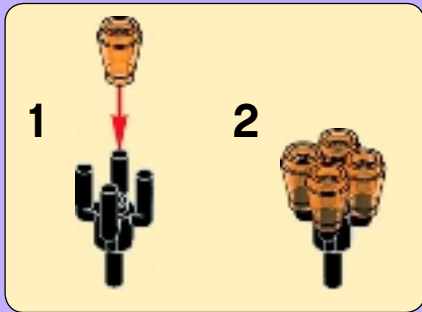



2x



2x

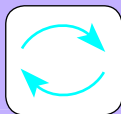

28



2x



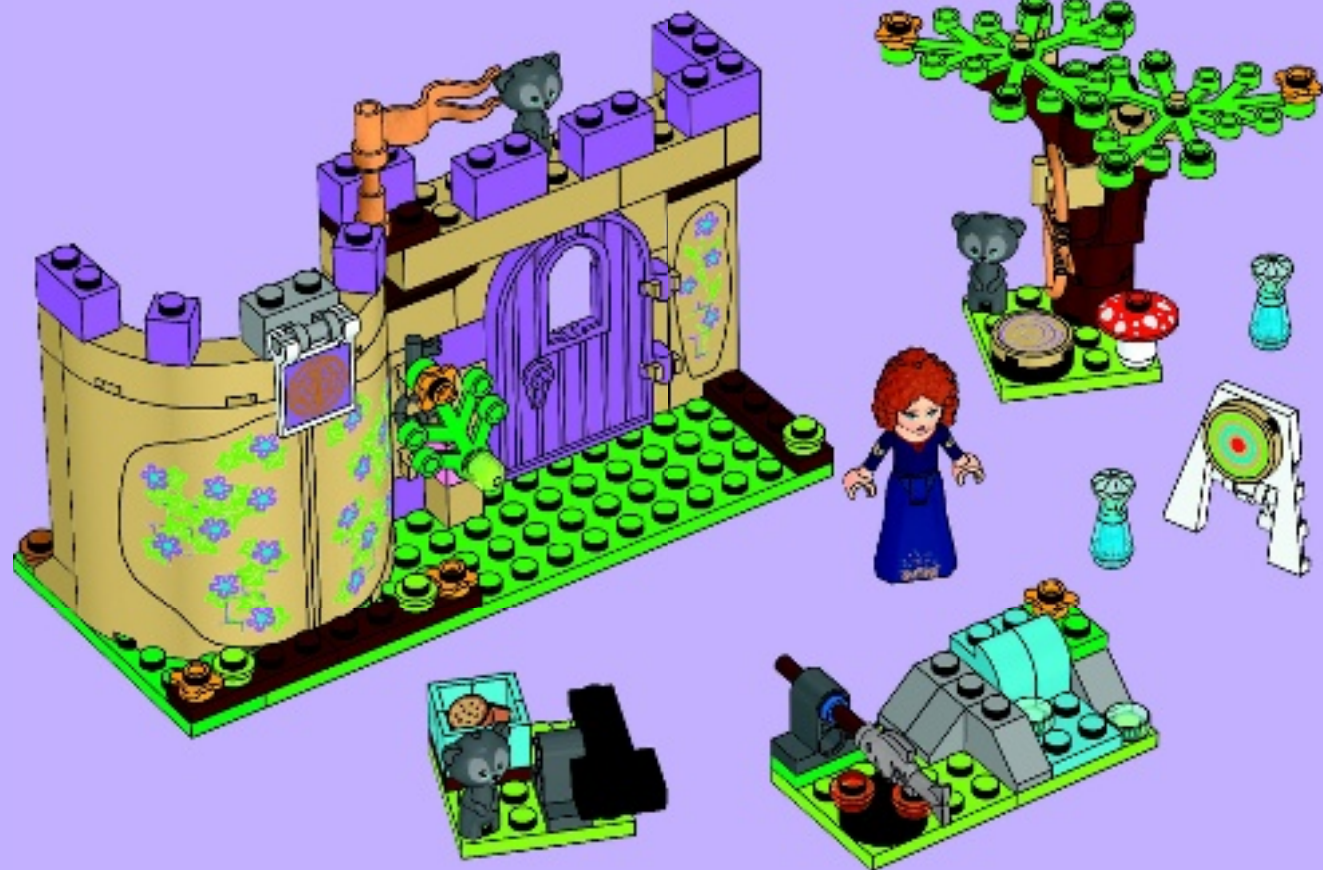



Customer Service

Kundenservice

Service Consommateurs

Servicio Al Consumidor

LEGO.com/service or dial



: 00800 5346 5555

: 1-800-422-5346



Friends



41039



41026



41029

Heartlake City





41027





Win!

Go to LEGO.com/productfeedback to fill out a survey for a chance to win a cool LEGO® Product.

No purchase necessary.
Open to all residents
where not prohibited.



LEGO.com/productfeedback

Gewinne!

Nimm an der Umfrage auf LEGO.com/productfeedback teil und hab die Chance ein cooles LEGO® Produkt zu gewinnen!

Die Teilnahme am Gewinnspiel führt zu keinerlei Kaufverpflichtungen. Teilnahme in allen nicht ausgeschlossenen Ländern möglich.

Win!

Ga naar LEGO.com/productfeedback, vul een enquêteformulier in en maak kans op een cool LEGO® product.

Geen aankoopverplichting. Ledereen mag deelnemen, uitgezonderd ingezetenden van landen waar een enquêteverbod geldt.

Gagne!

Visite LEGO.com/productfeedback pour répondre à un questionnaire et avoir une chance de gagner un produit LEGO® très cool!

Aucune obligation d'achat. Ouvert à tous les résidents des pays autorisés.

当てよう!

LEGO.com/productfeedbackにアクセスして、アンケートにご記入ください。当選者にはレゴ製品を差し上げます。

お買い上げの必要はありません。

禁止されていない限り、すべての皆様にご利用いただけます。



LEGO.com

6074042

LEGO and the LEGO logo are trademarks of the/son des marques de commerce de/son marcas registradas de LEGO Group. ©2014 The LEGO Group. © Disney